

Surprise with Admiration  
Unfolds from Here

**"PATENTED"**



**EXTEND LIGHT MACHINERY CO., LTD.**

No.7, Lane 568, Erkan Road, Shuei-Mei Village,  
Waipu Dist, Taichung City, 438, Taiwan Province

tel: +886-4-2686-7755(rep.)

fax: +886-4-2686-2266

e-mail: extendlt@ms13.hinet.net

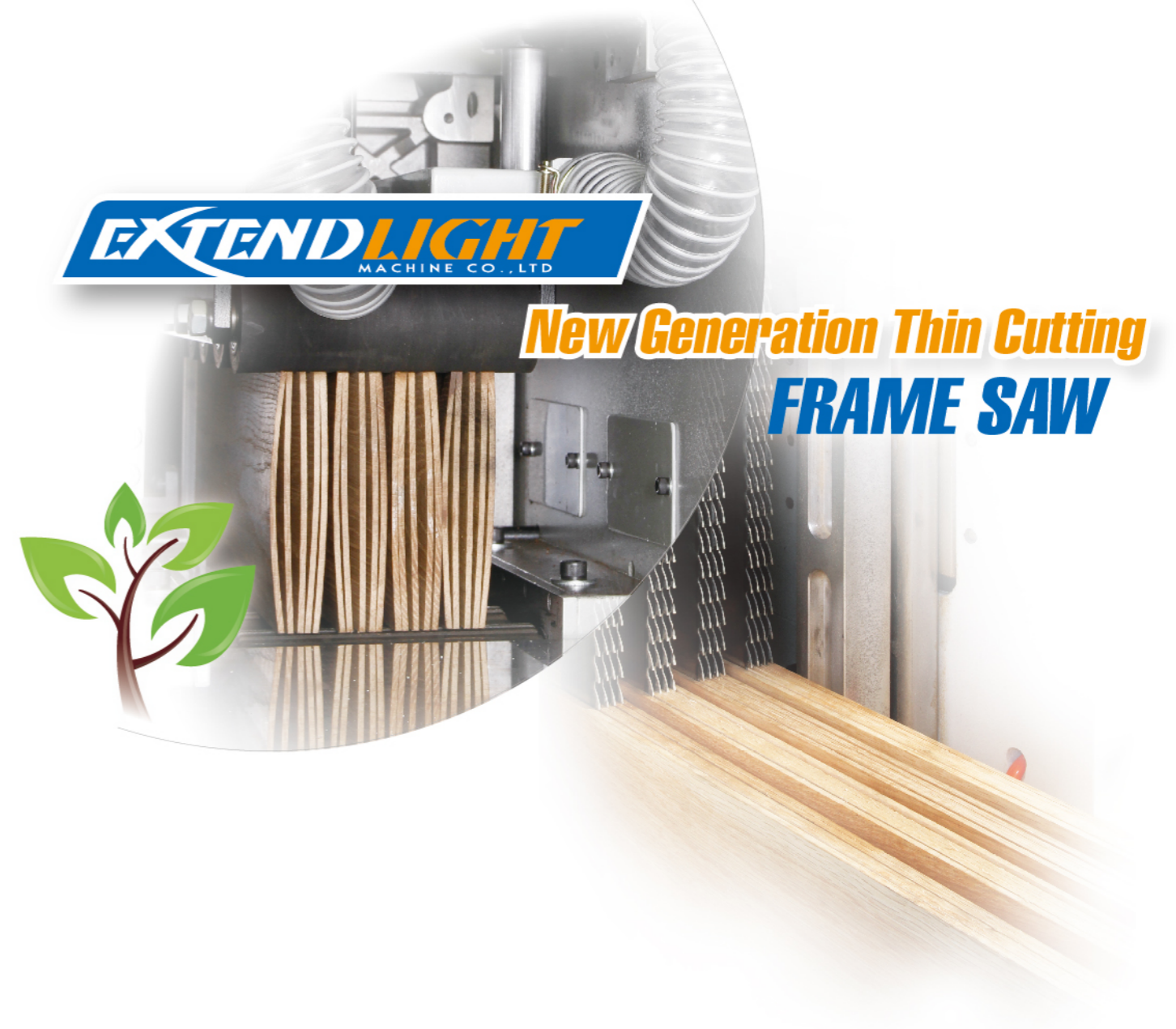





EXTEND LIGHT MACHINERY CO., LTD. specializing in the production - a high-performance frame saw, the whole series models are equipped with an exclusive patented synchronous servo feed system, can achieve the perfect low-loss high-sawing process, the application of industrial branched out into wood furniture, wood doors, wood flooring, bamboo flooring , wooden walls ..... System for the ability to provide professional customized services for unique requirements.



Provide a full range of technical support to help customers improve processes and innovation through research and development, creating high profit.

Not only is the equipment provider, is the primary problem solver customers .





New Generation Thin Cutting **FER200 / 250 / 300 / 200W4**



Following the trend of coexistence of environment and technology,  
we provide a perfect interpretation.

Promise of High Efficacy · Low Loss · High Precision · Low Noise

No need for redundant explanation, but being brave for challenging  
the conventional practice is the right thing to get esteem.



## Convenient frame replacement

The front and rear machine plates can be separated to facilitate mounting or dispatching of the saw frame.  
Upper roller is driven by chain.



Each pressure roller could be adjusted independently

### High-rigidity body structure

Eliminating the vibration and slide aroused by the operation of machine.

### Automatic lubrication of main saw frame. Lubrication frequency as digitally controlled.

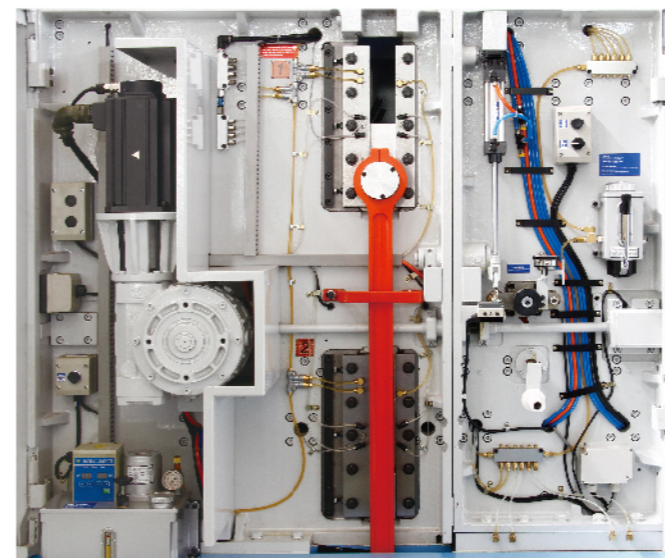

- Feed rollers are driven by servomotor.  
Sawblade running speed accuracy matches feed speed.

It boosts the accuracy and reliability of simultaneous cutting devices by the accurate serve feeding system controlling.

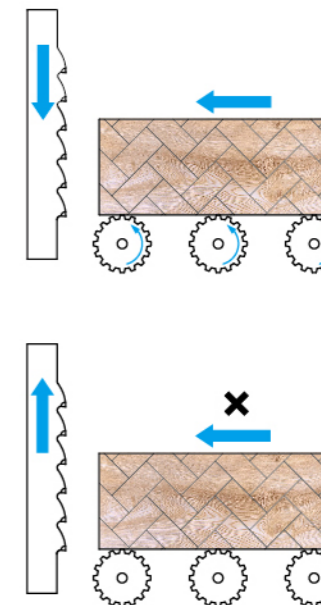

### Convenient control panel

The centralized control panel provides mazimum operation convenience. Major control functions include: feed speed display, feed speed regulation, timer, start and stop controls, mergency stop and air control.



- Standard

### Rear pressure roller height adjusting system

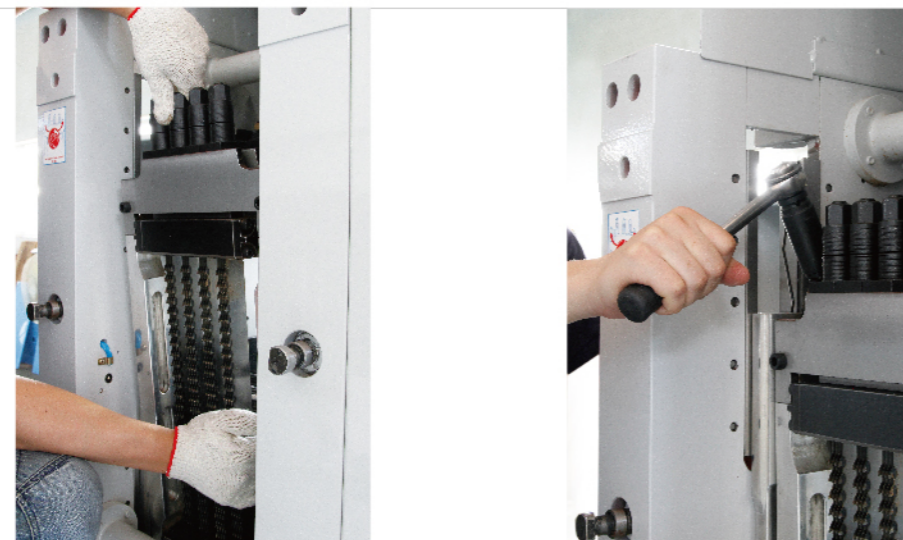

Quick and safe design to changing blades

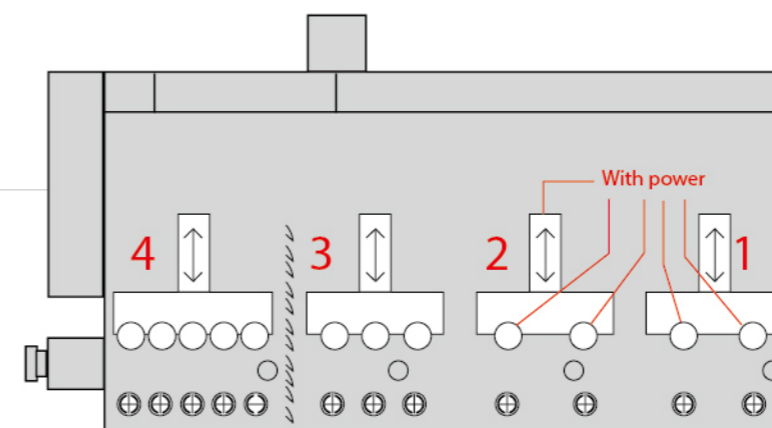

Cylular

Senser

Bottom all with power





Concentrated disposition of electric components makes examination, repair, and cleaning easy.

Finished product rack.

Upper feed roller adopts chain drive with chain allowance automatic compensation system attached.

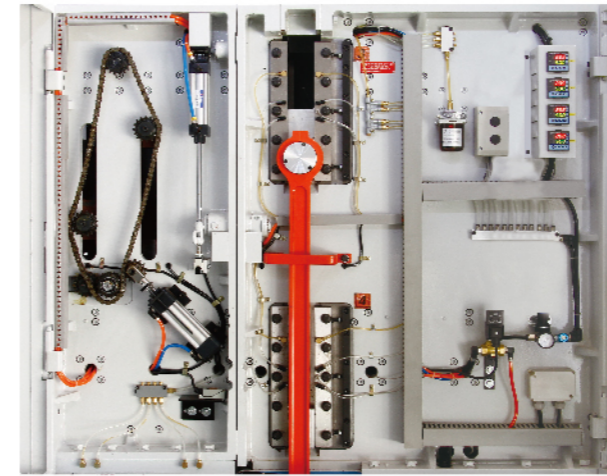

Displayer micro computer temperature controller



Each slider with a temperature indicate, have 4 piece's temperature over 46 °C the light will shining. Must check be stop immediately and check it for protect machine.

Efficient dust removal

The upper and lower air blast nozzles, provided at the back side of the blades, are used for cooling blades and removing saw dust. 5x5 hold dust chutes are equipped on the machine.



Rugged structure

The saw frame is manufactured from durable aluminum alloy, permitting proper sawblade running at all times.

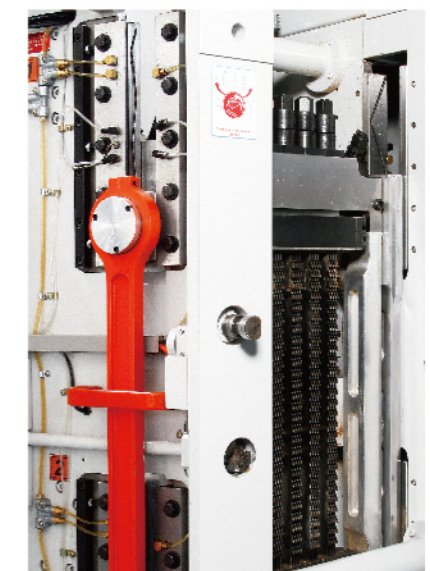



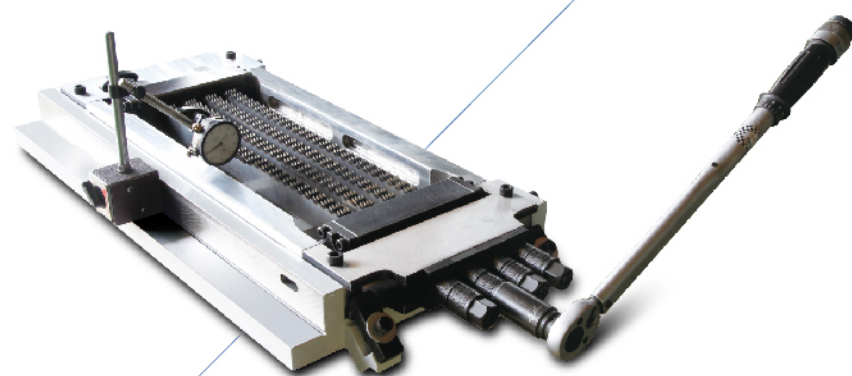
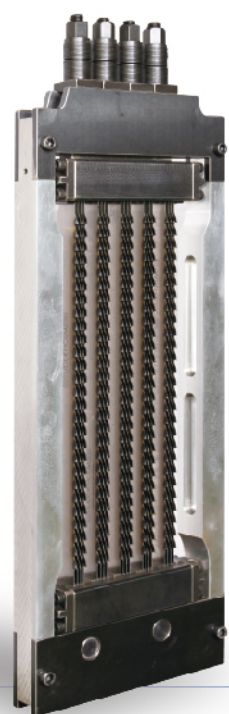
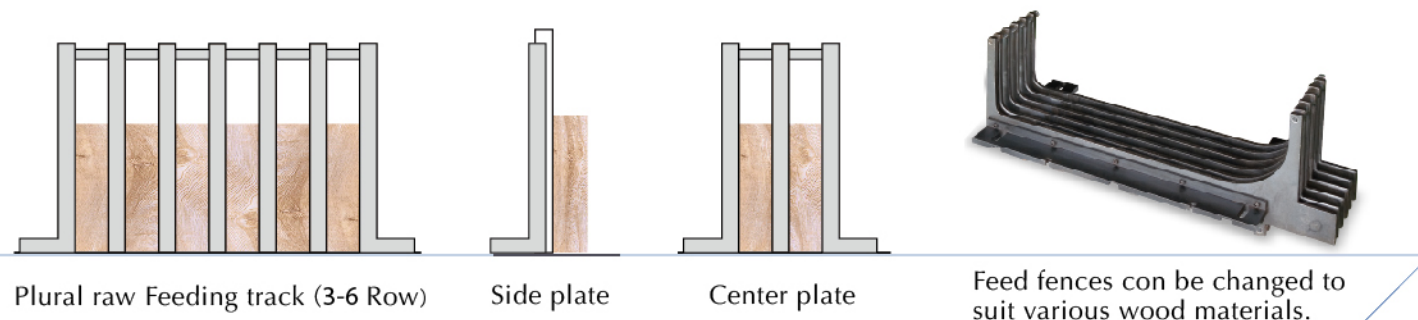

### Machine Description

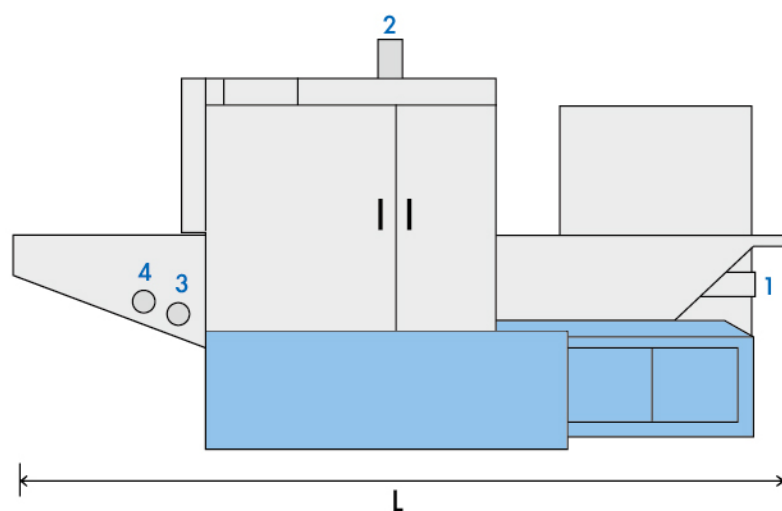
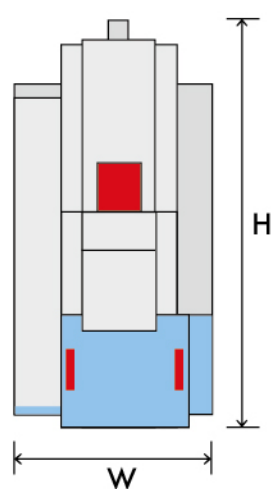

### Machine Specifications

MODEL	FR-200	FR-200W4
Horsepower	25hp	50hp
Feeding system output power	7.5hp (servo)	7.5hp (servo)
Open machine power	0.5hp	0.5hp
Max. Working High	205mm	205mm
Min. Working High	70mm	70mm
Max. Working Width	150mm	400mm
Min. Working Length	400mm	400mm
Feed Speed	0.1~2.0m/min	0.1~2.0m/min
Saw blade Speed	480stroke/min	480stroke/min
Saw blade Stroke	210mm	210mm
Saw blade Size	500x40x0.7~0.9mm Kerf:1.1~1.4	500x40x0.7~0.9mm Kerf:1.1~1.4
Saw blade Material	TCT or stellite	TCT or stellite
Max upload quantities of Saw blades	24 pieces	32 pieces
Finished Tolerance Value	± 0.1mm	± 0.1mm
Min Precision Thickness	2.0mm	2.0mm
Dust Pipe	5"x 4 pieces	5"x 4 pieces
Machine Dimensions	L3700xW1000xH1900 mm	L3700xW1300xH1900 mm
Packing Dimensions	L3900xW1600xH2200 mm	L3900xW1600xH2200 mm
Net Weight	4200 kgs	5000 kgs
Gross Weight	4400 kgs	5400 kgs

MODEL	FR-250	FR-300
Horsepower	30hp	40hp
Feeding system output power	7.5hp (servo)	7.5hp (servo)
Open machine power	0.5hp	0.5hp
Max. Working High	255mm	310mm
Min. Working High	70mm	110mm
Max. Working Width	150mm	200mm
Min. Working Length	400mm	400mm
Feed Speed	0.1~2.0m/min	0.1~2.0m/min
Saw blade Speed	480stroke/min	480stroke/min
Saw blade Stroke	210mm	260mm
Saw blade Size	550x40x0.8~0.9mm Kerf:1.2~1.4	655x45x0.8~0.9mm Kerf:1.2~1.4
Saw blade Material	TCT or stellite	TCT or stellite
Max upload quantities of Saw blades	28 pieces	30 pieces
Finished Tolerance Value	± 0.1mm	± 0.15mm
Min Precision Thickness	2.5mm	3mm
Dust Pipe	5"x 4 pieces	5"x 4 pieces
Machine Dimensions	L3700xW1000xH1950 mm	L3700xW1050xH2050 mm
Packing Dimensions	L3900xW1600xH2200 mm	L3900xW1200xH2200 mm
Net Weight	4500 kgs	5000 kgs
Gross Weight	4700 kgs	5200 kgs

\* FR-200 can option 450mm length saw frame, FR-300 can option 620mm length saw frame.

● All specifications, dimensions and design characteristics shown in this catalogue are subject to change without notice.



## SG-65 Sharpener



SG-65 Sharpener equipped with high-accuracy double shafts servo control, prolonging saw blade life and lower lost of sharp errors substantially.



All built-in Sawing Group Parameters, you do not need to key-in or revise confoundedly

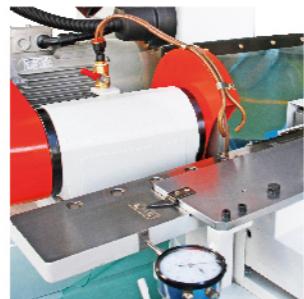
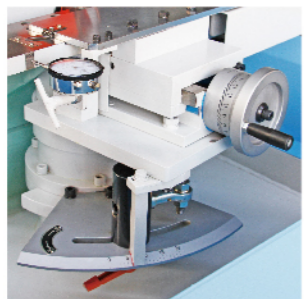
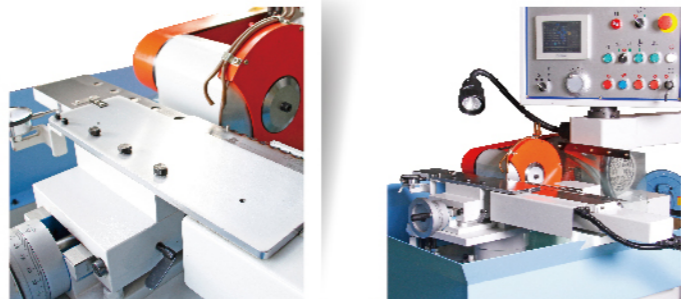

### Machine Specifications

MODEL	SG-65
Spindle Power	2HP
Cooling Motor	1/6HP
X axis servo motor	X axis 100W
Y axis servo motor	Y axis 400W
controller	Mitsubishi
Machine size	L1400*W1000*H1665mm
Packing size	L1500*W1100*H1700mm
N.W.	400 KG
G.W.	450 KG

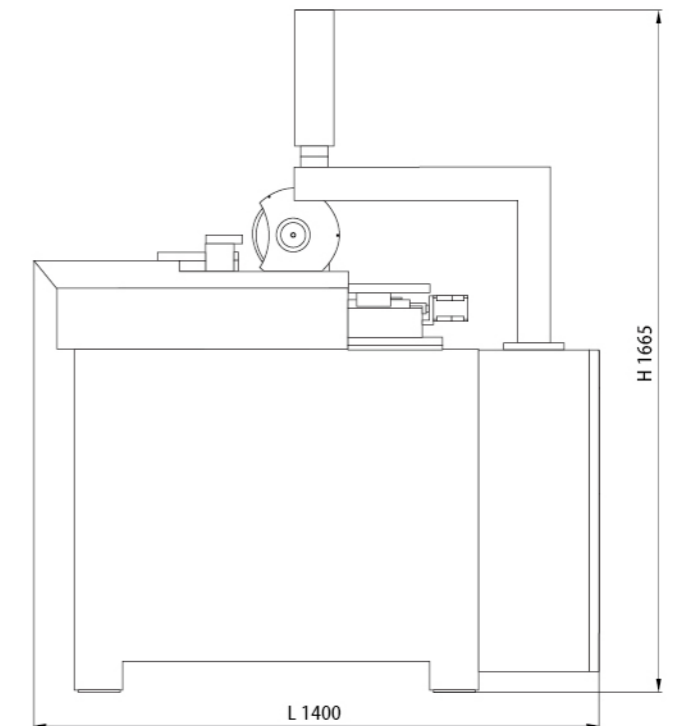
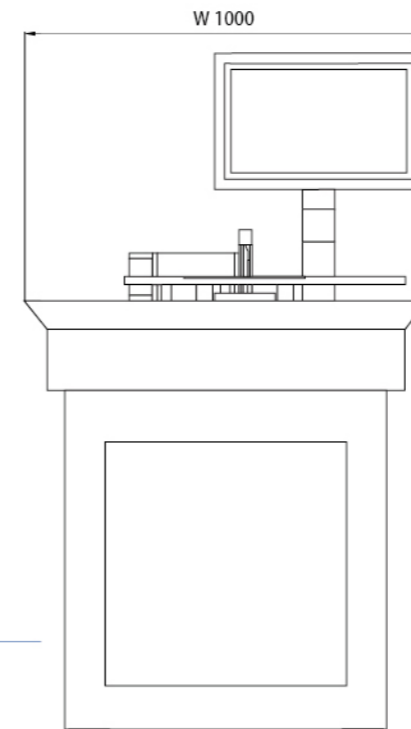





**SBT-010**  
Saw Blade Tensioner

Machine Specifications

MODEL	SBT - 010 Saw Blade Tensioner
Spindle Power	0.3 kw
Machine size	L600 * W300 * H1100 mm
Packing size	L800 * W500 * H1300 mm
N.W.	75 kg
G.W.	95 kg

